

LEGO

BIONICLE

71307



LEGO.com/bionicle





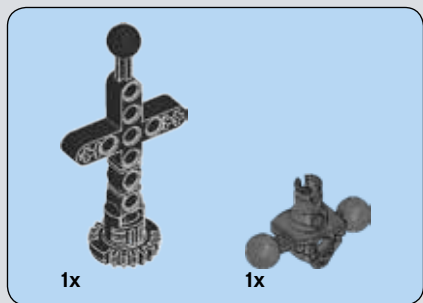

1

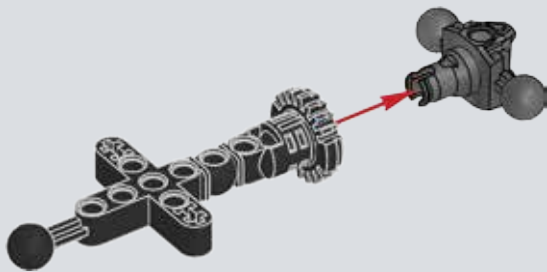

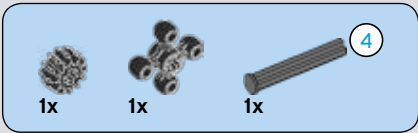

2

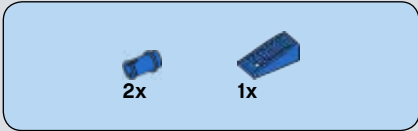
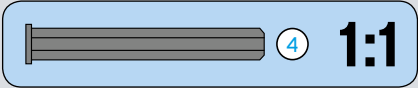
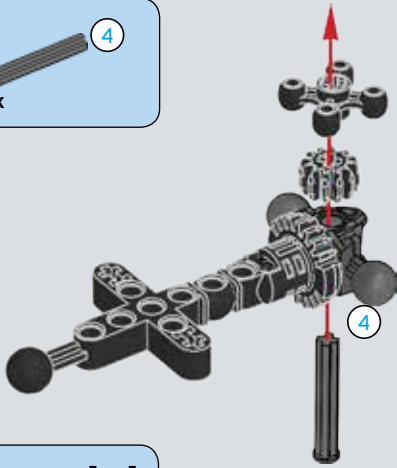

3

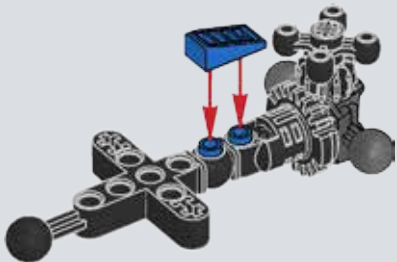



1x



1x



1x

4

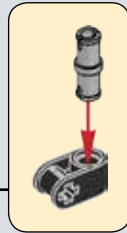
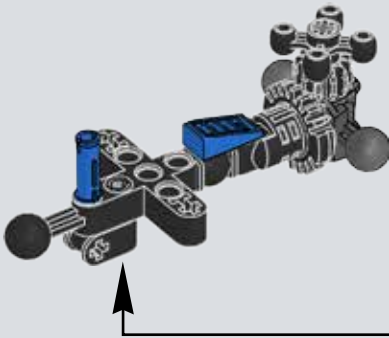

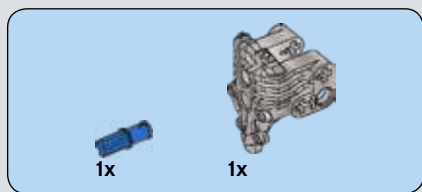

5

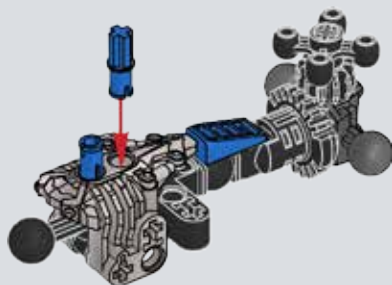

6

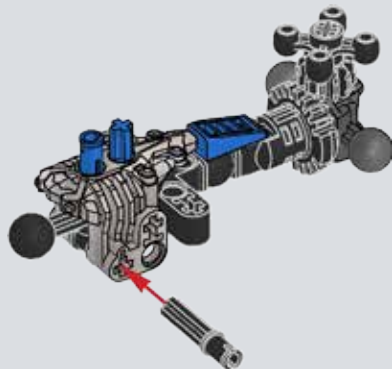

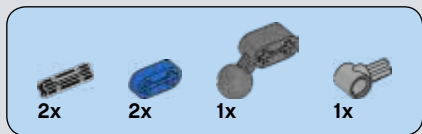

7

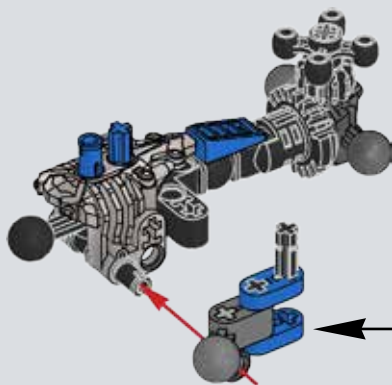
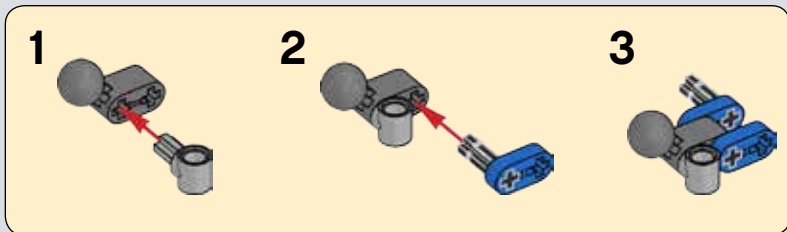

8

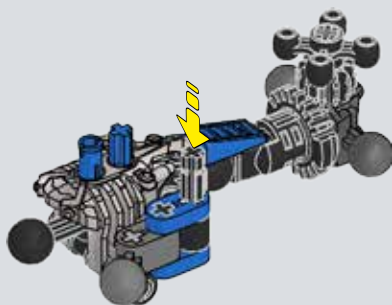

8

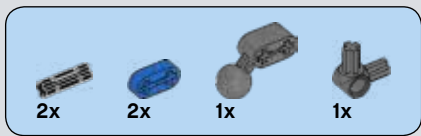

9

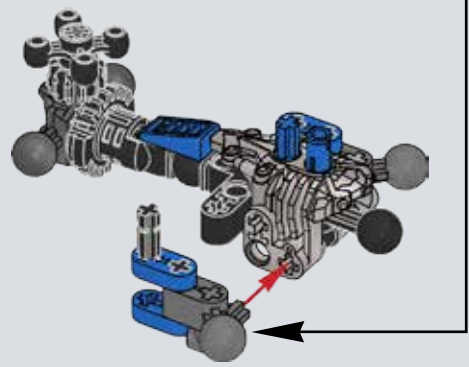
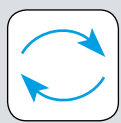
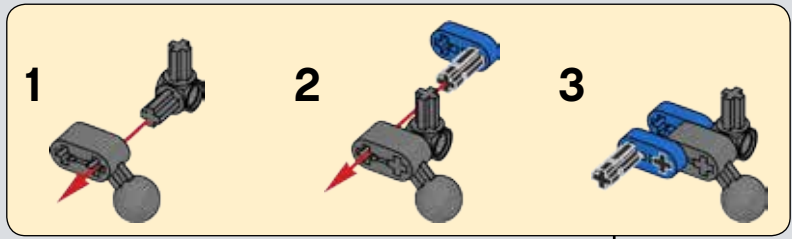

10

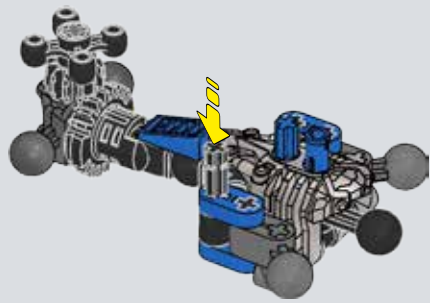

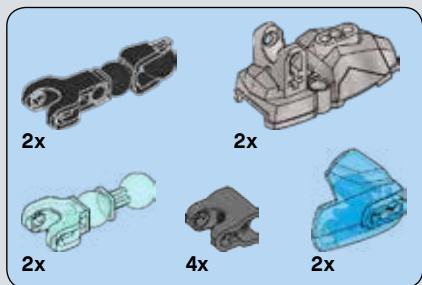

11

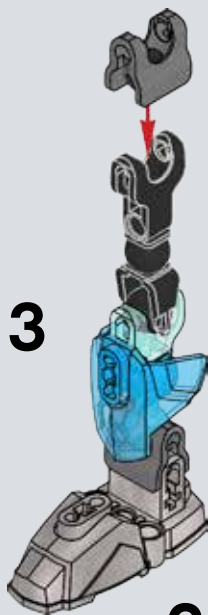
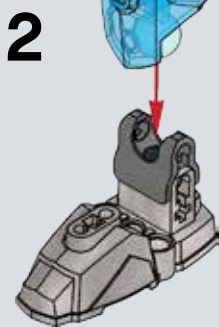
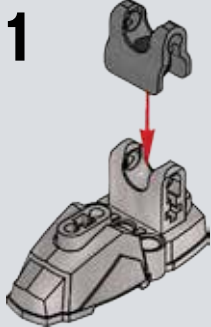
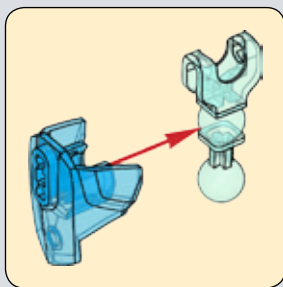

2x

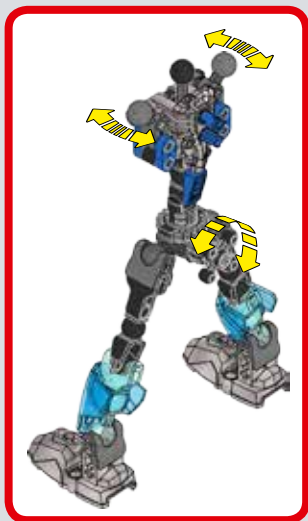
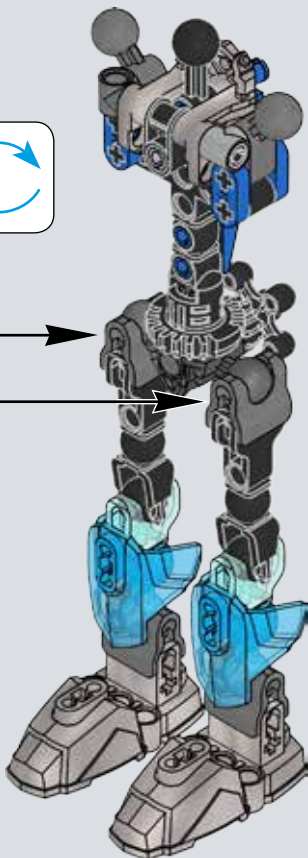
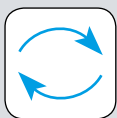



12

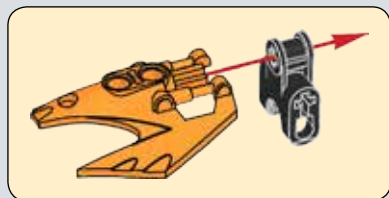
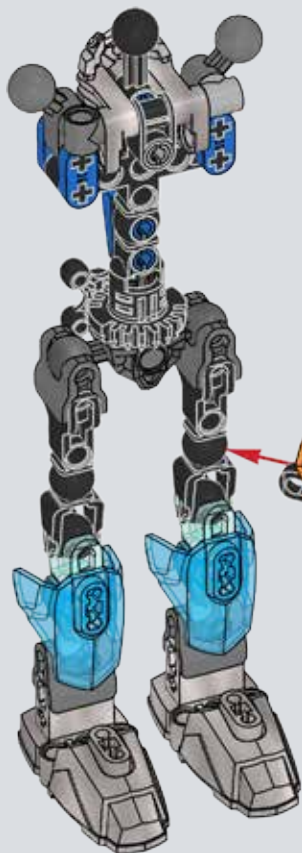



1x

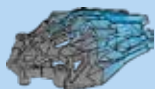

1x

13

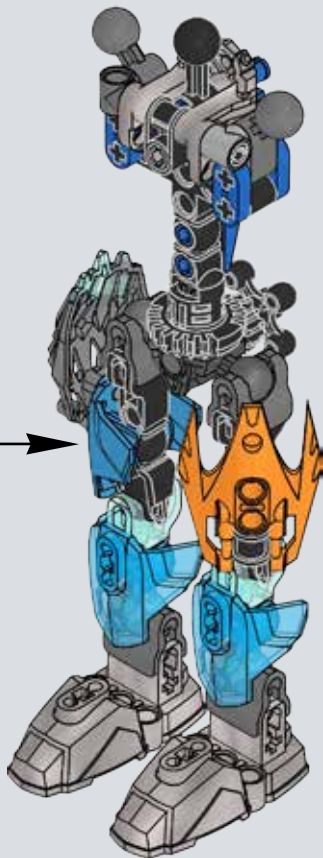
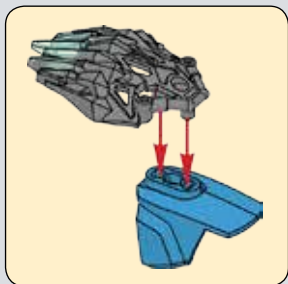

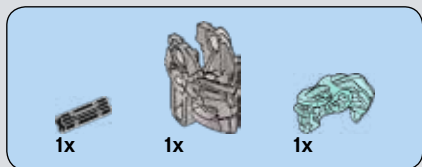

14

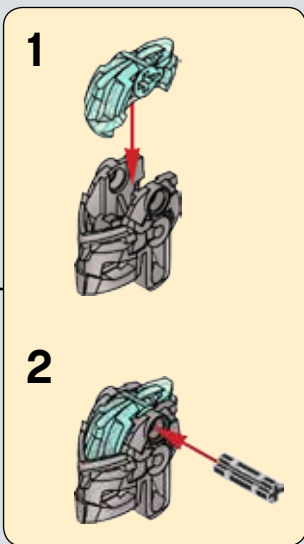
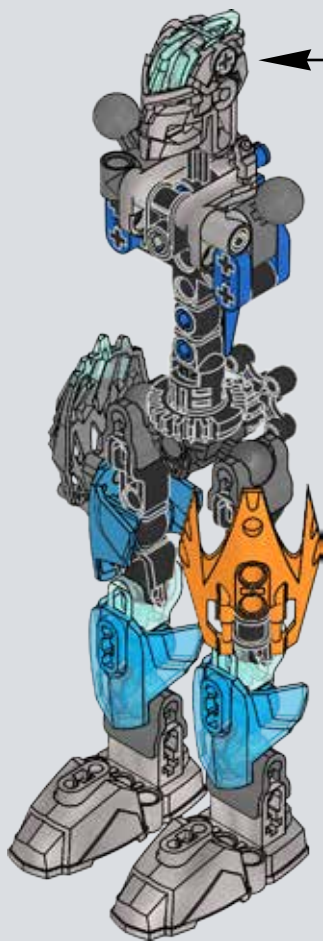



15

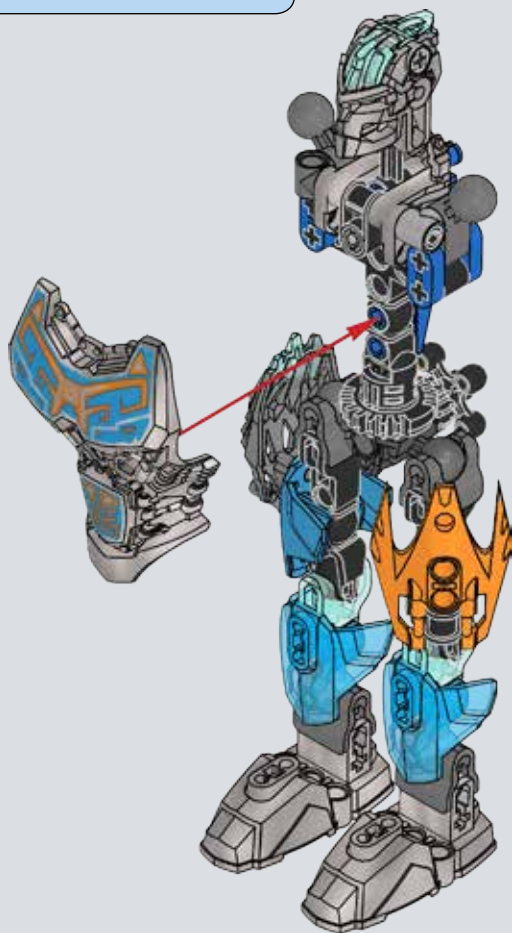

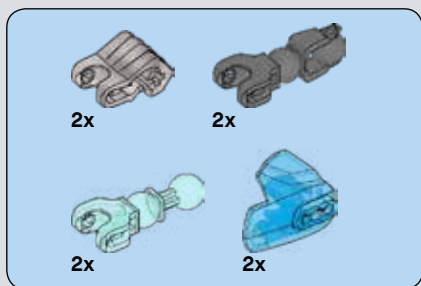

16

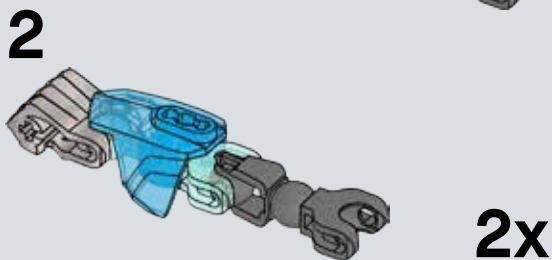
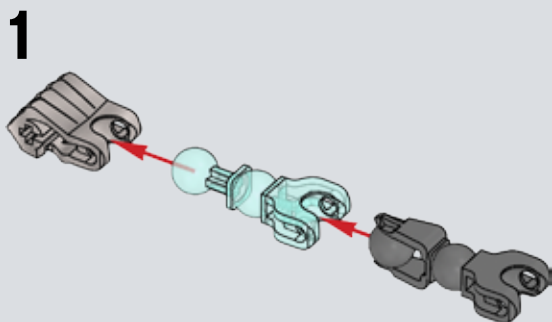



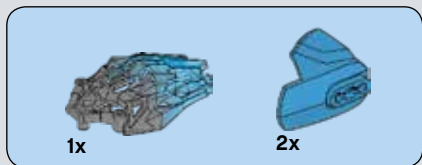

17



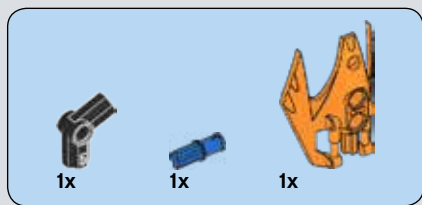

18

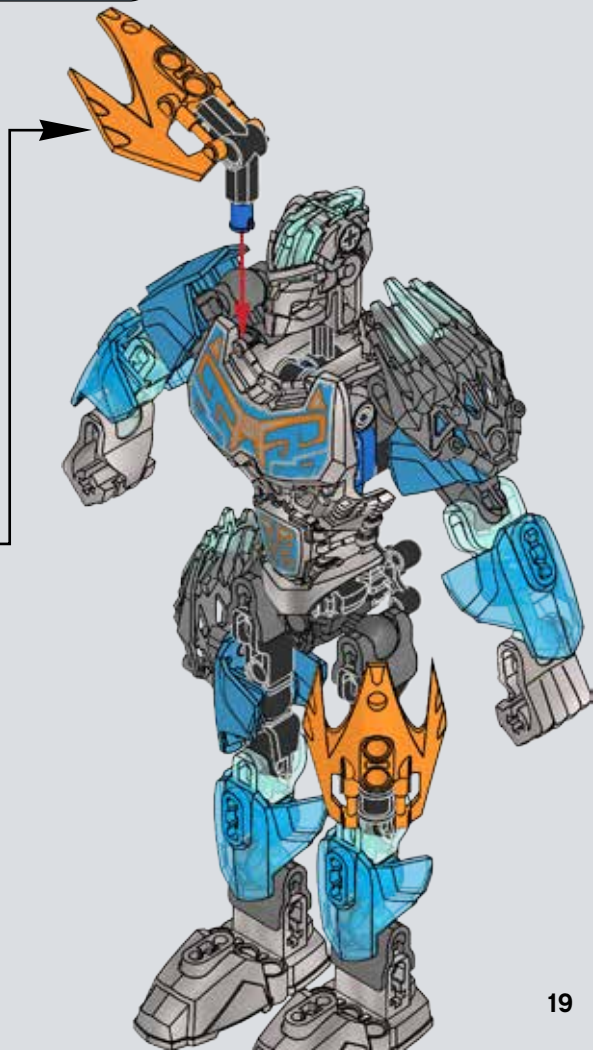
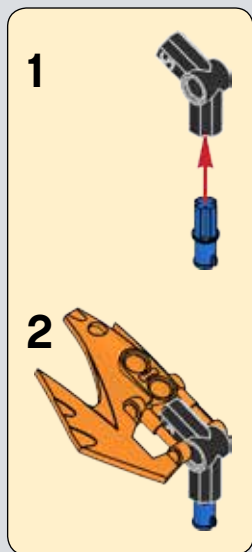

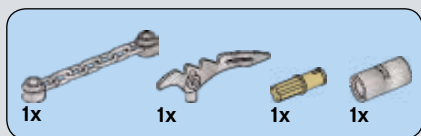

19

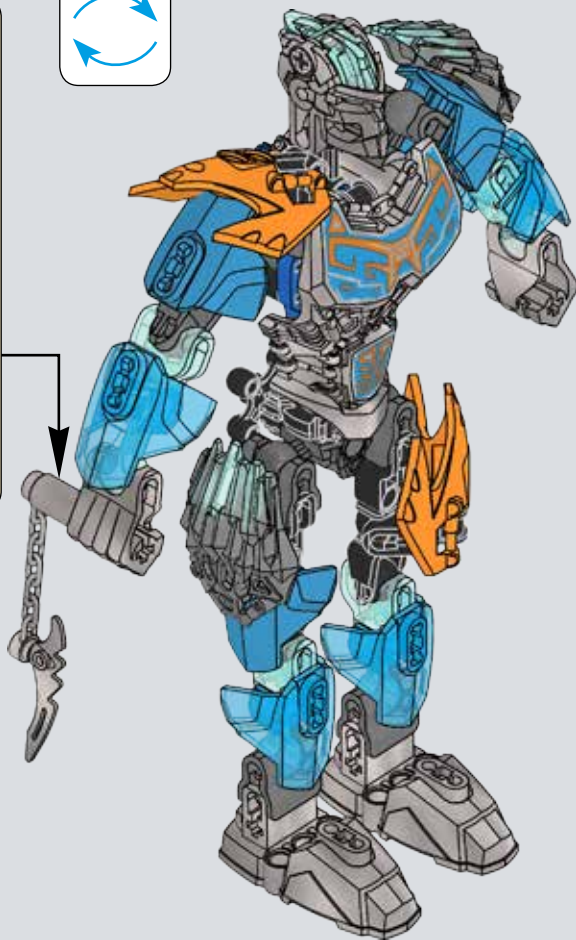
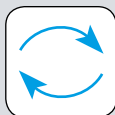
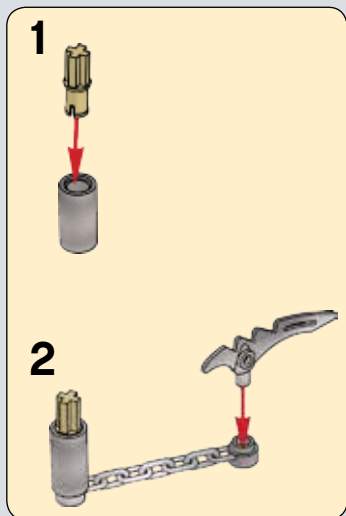

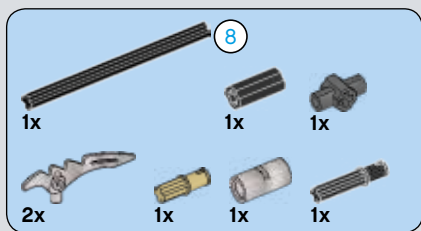

20

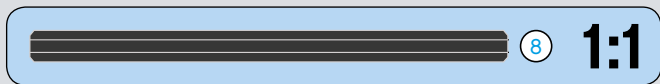
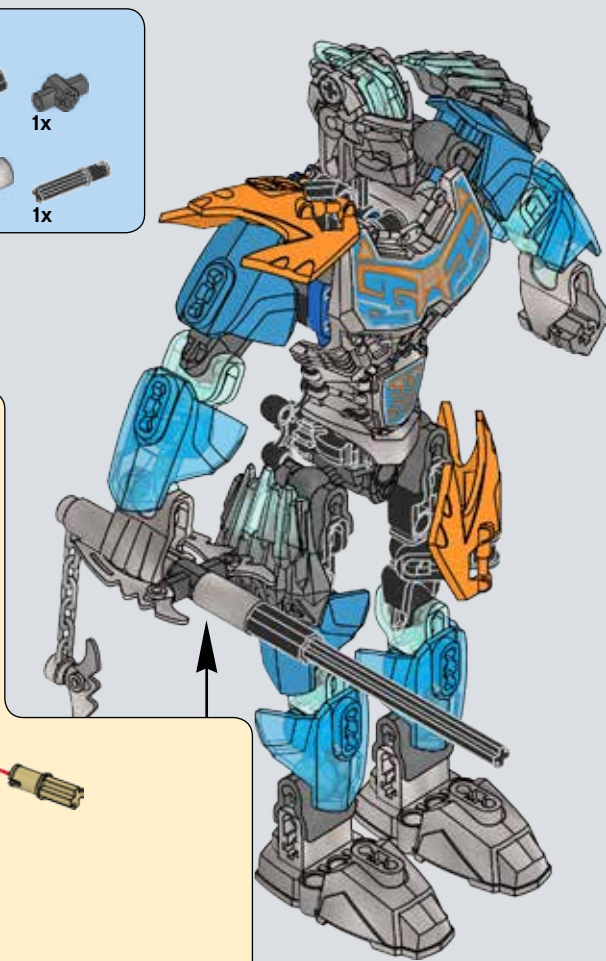
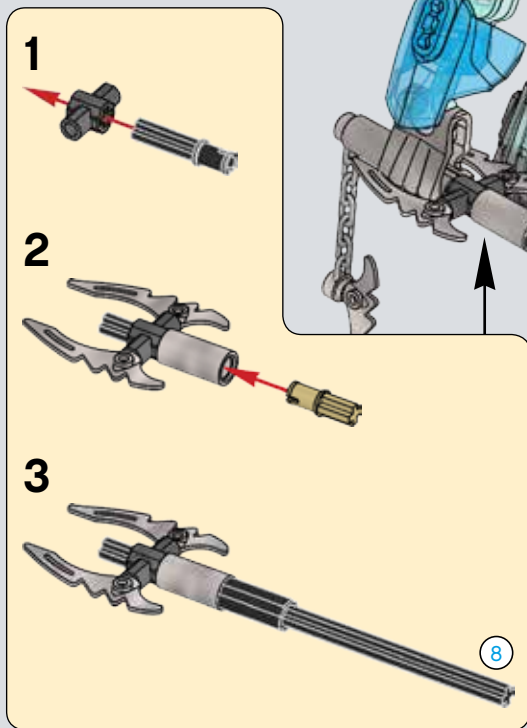

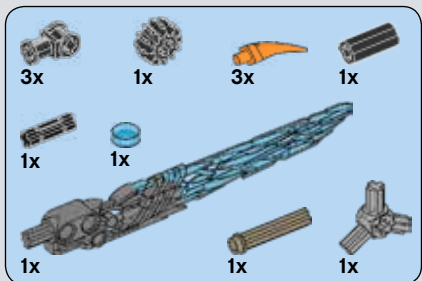

21

1

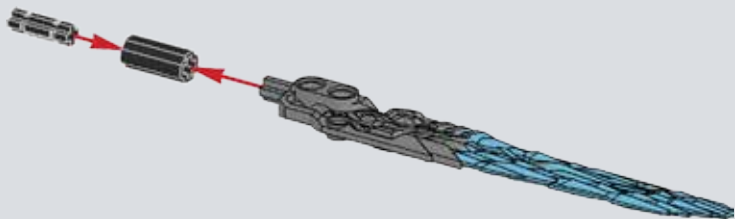

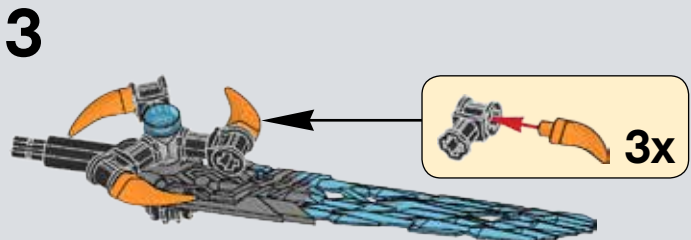
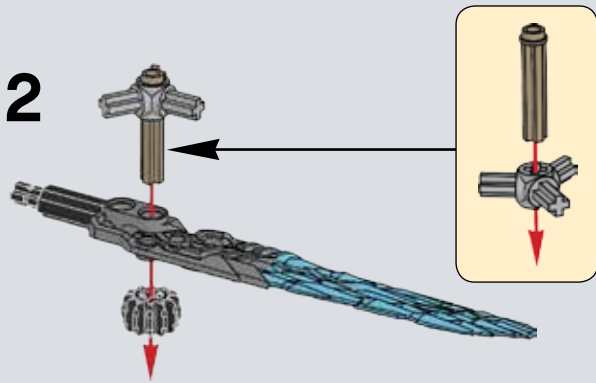

22

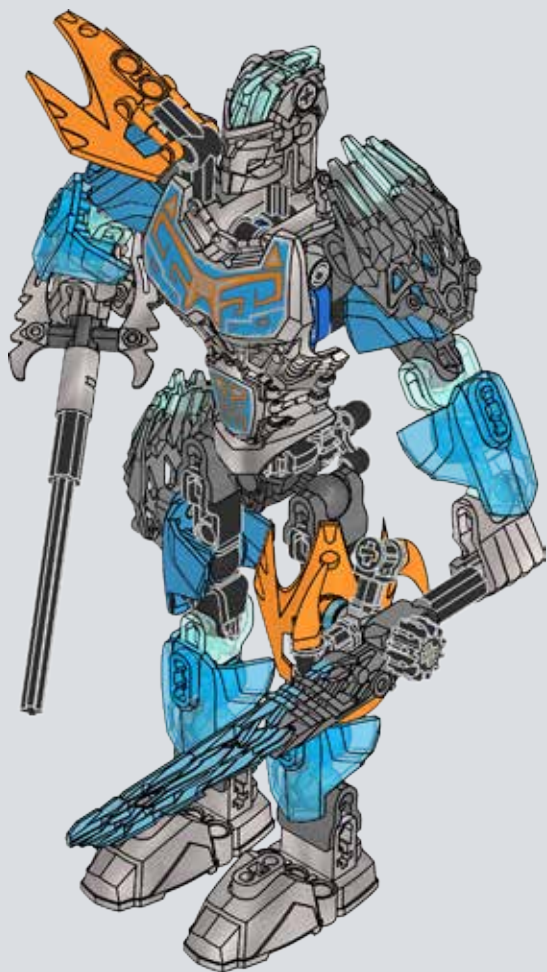
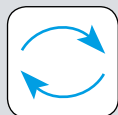

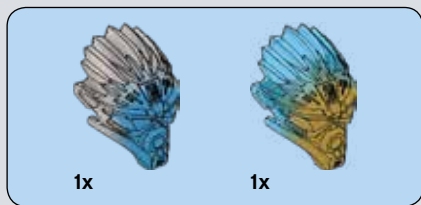

23

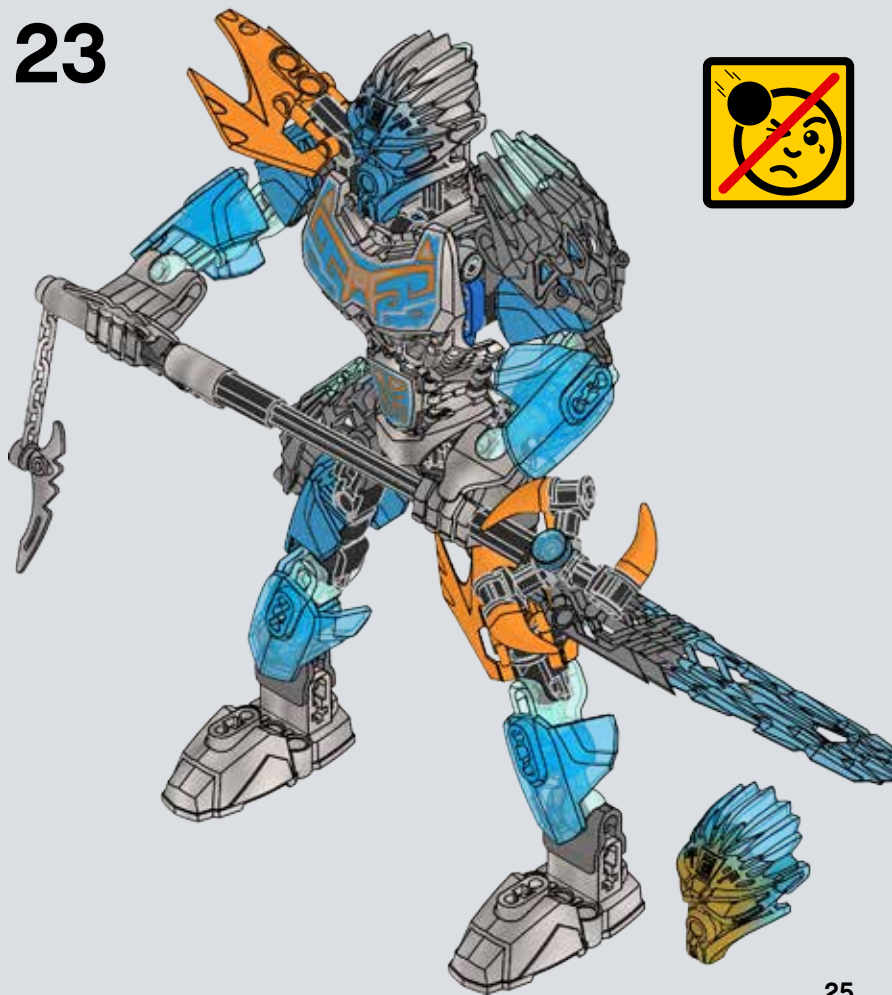

2x
4666579

2x
4143005

4x
4186834

2x
4206482

1x
4597338

1x
4514553

2x
4177431

6x
4109810

1x
4173668

1x
4107084

3x
4107081

1x
4610948

1x
6135125

2x
4593562

1x
370726

1x
4248204

2x
6089119

2x
4512363

1x
6135238

4x
6043679

3x
6133035

2x
6136441

1x
6031821

1x
4211807

1x
6123815

1x
4502595

1x
6005331

4x
6106472

2x
4289258

1x
6083620

2x
4622903

2x
6054858

1x
6102606

2x
4619077

1x
6135036

1x
6135237

3x
4651535

1x
6064049

1x
6139118

2x
4632585

1x
6150659

1x
6135325

1x
6139106

3x
6139225

1x
4646861

4x
6139220

2x
6147641

1x
6135037



Customer Service

Kundenservice

Service Consommateurs

Servicio Al Consumidor

LEGO.com/service or dial



00800 5346 5555 :



1-800-422-5346 :



LEGO

BIONICLE

71310



UNITE for battle



71302+71307

 LEGO.com/bionicle

UNIS-LES pour le combat
Sólo podemos luchar UNIDOS

Download App
Télécharger l'application
Descarga la App



NETFLIX

 Download on the
App Store

Apple, the Apple logo, iPad, iPhone and iPod touch are trademarks of Apple Inc.
Apple, le logo Apple, iPad, iPhone et iPod touch sont des marques de commerce d'Apple Inc.
Apple, el logotipo de Apple, iPad, iPhone e iPod touch son marcas comerciales de Apple Inc.

GET IT ON
 **Google play**

Google Play is a trademark of Google Inc.
Google Play est une marque de commerce de Google Inc.
Google Play es una marca comercial de Google Inc.



71300



71305



71301



71306



71302



71307



71303



71308



71304



71309



71311



71311





71311

71302

71301

71311

71307

71306



71303



71300



71304



71308



71305



71309

