



# CLASSIC

10709







 [LEGO.com/classic](https://www.lego.com/classic)



**WARNING: CHOKING HAZARD.**  
Small parts. Not for children under 3 years.

 Easy Building  
Construction facile  
Construcción fácil

  
 Medium Building  
Construction intermédiaire  
Construcción intermedia

  
  
 Advanced Building  
Construction avancée  
Construcción avanzada



p./pag.

 8

 **AVERTISSEMENT : RISQUE D'ÉTOUFFEMENT.**  
Contient des petites pièces. Ne convient pas aux enfants de moins de 3 ans.

 **ADVERTENCIA: PELIGRO DE ASFIXIA.**  
No recomendado para niños menores de 3 años. Contiene piezas pequeñas.



p./pag.  
 **16**

p./pag.  
 **26**





How did we get here?  
Comment est-on arrivés ici ?  
¿Cómo es que llegamos hasta aquí?

1932



4



1955

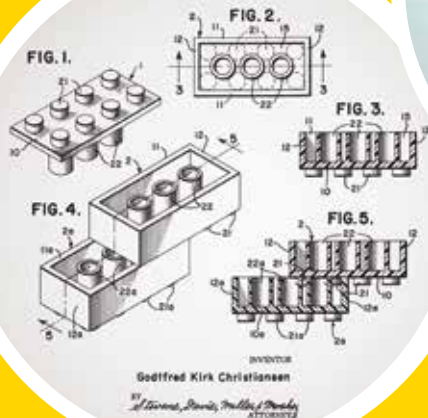

1958



1989



2017 >



1998



**Join my journey!**  
**Joins-toi à l'aventure !**  
**¡Únete a mi viaje!**



Name:  
**Roberta Cardazzo**

Nationality:  
**Italian**

Loves:  
**Photography, traveling, good food**

Motto:  
**Look at change as an opportunity  
for enrichment**



Nom :  
**Roberta Cardazzo**

Nationalité :  
**Italienne**

Elle adore :  
**La photographie, les voyages, la bonne cuisine**

Devise :  
**Regarder le changement comme une  
possibilité d'enrichissement**



# Roberta

Learn more about the designers online.  
Renseigne-toi sur les designers en ligne.  
Más información sobre los diseñadores  
en Internet.

Nombre:  
**Roberta Cardazzo**

Nacionalidad:  
**Italiana**

Le encanta:  
**La fotografía, viajar y la buena comida**

Lema:  
**El cambio es una oportunidad para  
enriquecerse**





1x



1x

1

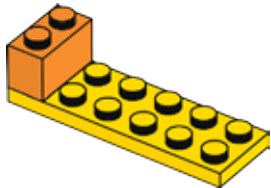





1x



1x

**2**

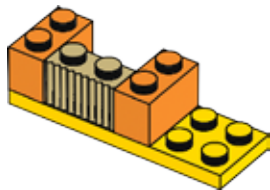

1x

**3**

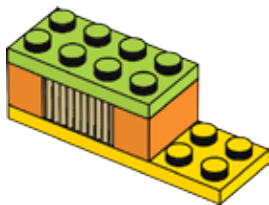

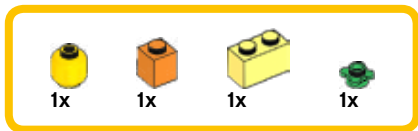

4

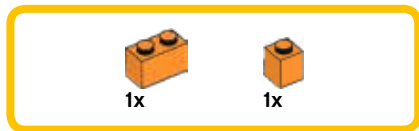
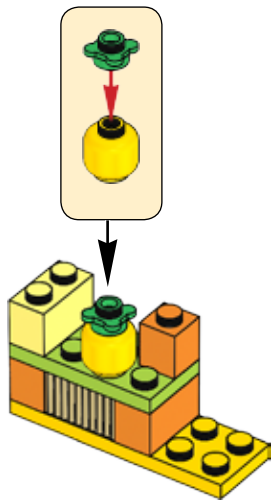

5

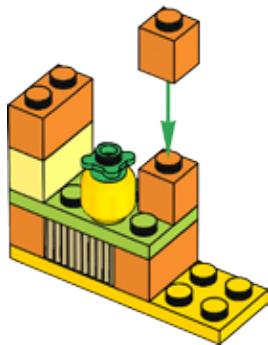

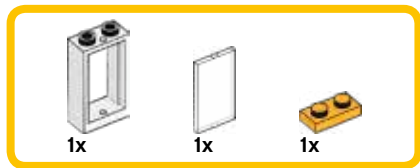

6

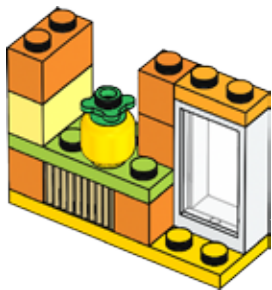
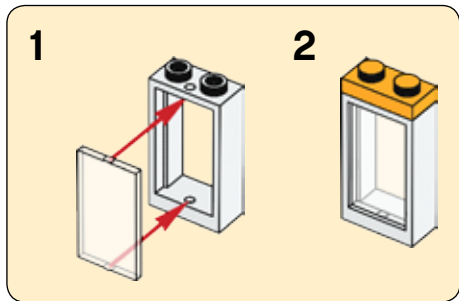

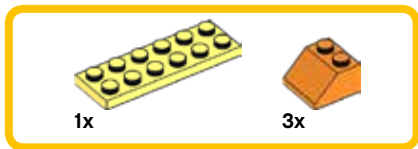

7

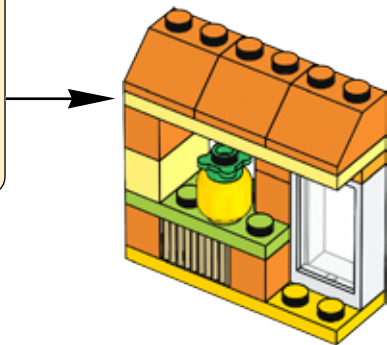
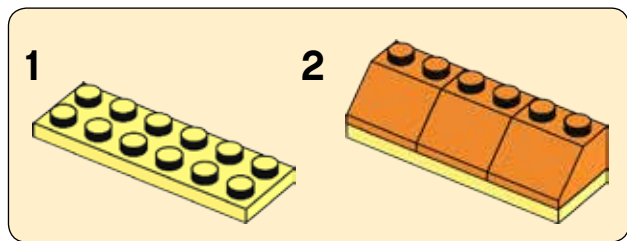



2x



1x

8

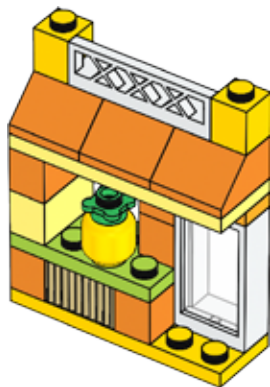

Combine endlessly!  
Combine à volonté !  
¡Combina sin límites!



10707



10709



ZZZZ!

10706



10708





1

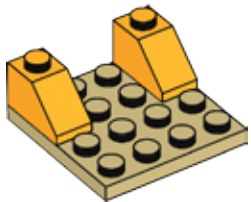





2x

2

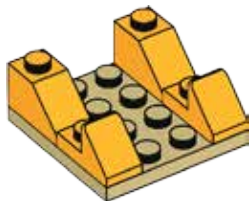

1x

3

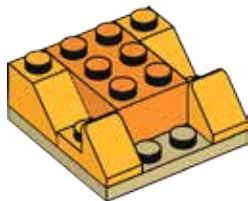



1x

4

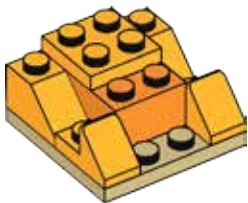

18



2x

5

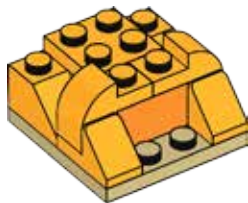



1x

6



2x

7

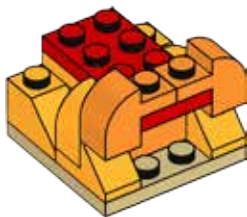



1x

8

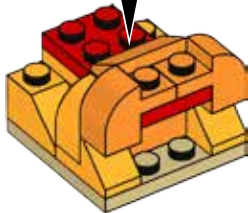
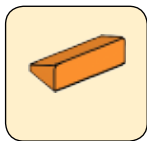

20



1x



1x

9

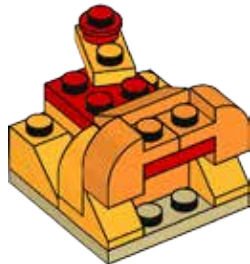
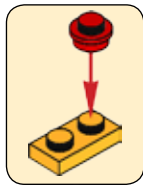



10

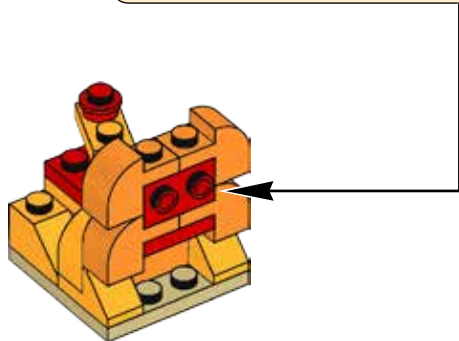
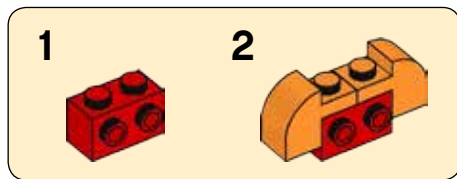



11

1



2



3



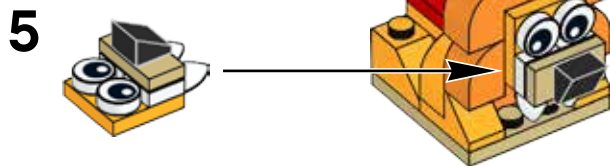

Imagine much more...  
Imagine bien plus encore...  
Imagina mucho más...



Sniff  
Sniff!!!







Share your orange  
creations in LEGO LIFE

Partage tes créations  
orange dans LEGO LIFE

Comparte tus creaciones  
naranjas en LEGO LIFE





1

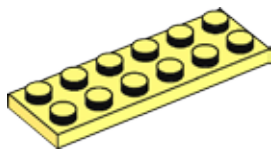



2x

2

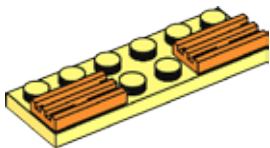

1x

3

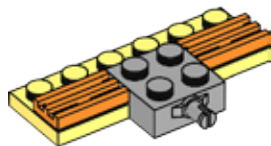

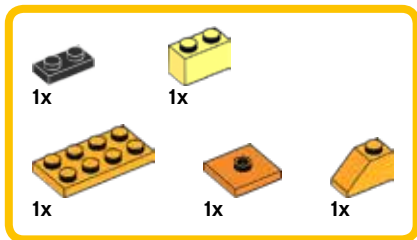

4







1x

5

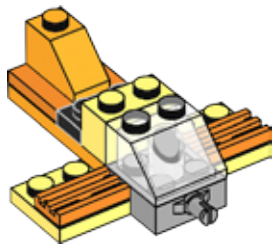

30

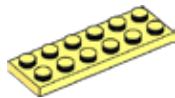

1x

6

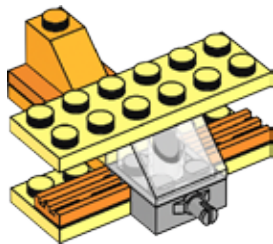



7

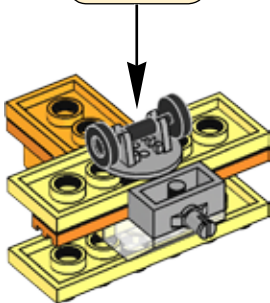
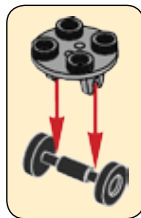
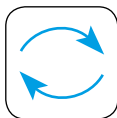



1x

8

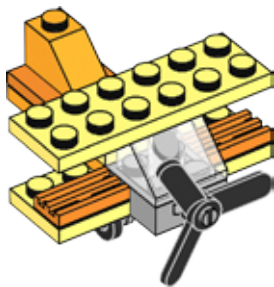
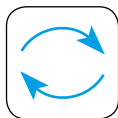





What will you build?  
Que vas-tu construire ?  
¿Qué construirás?



10699



10700



10701



34



10698



10696



10692



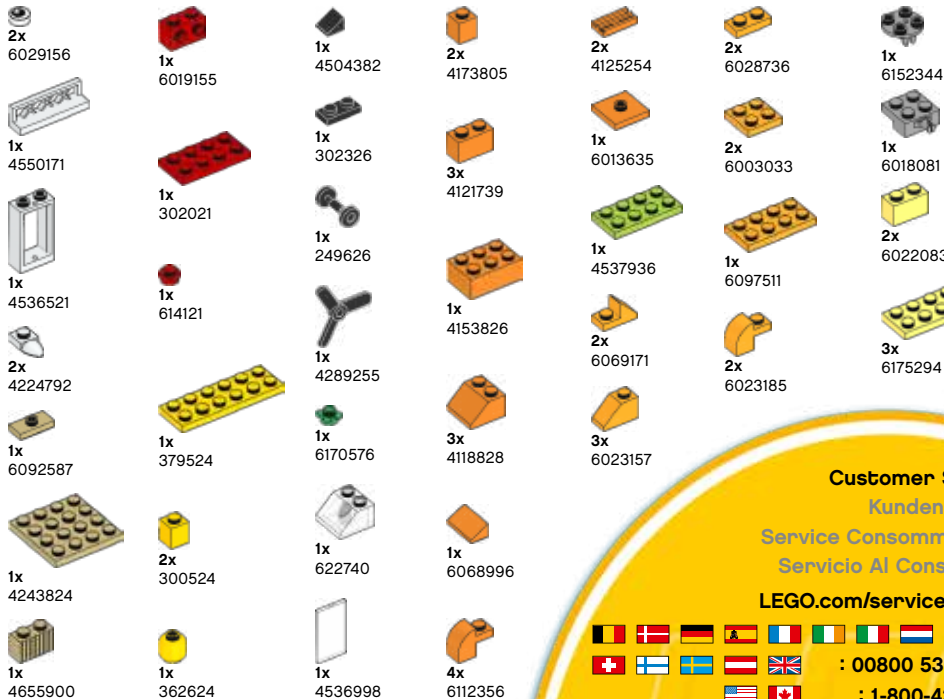

**Customer Service**

**Kundenservice**

**Service Consommateurs**

**Servicio Al Consumidor**

**LEGO.com/service or dial**



# WIN

GO TO [WWW.LEGO.COM/PRODUCTFEEDBACK](http://WWW.LEGO.COM/PRODUCTFEEDBACK) AND  
GIVE US YOUR SHORT **FEEDBACK** ABOUT THIS  
LEGO® SET FOR A CHANCE TO WIN  
A COOL LEGO PRIZE.

Terms & Conditions apply

## LEGO.com/productfeedback



### GEWINNE



Erzähle uns auf  
[www.LEGO.com/productfeedback](http://www.LEGO.com/productfeedback)

etwas über die Erfahrungen, die du  
mit diesem LEGO® Set gemacht hast,  
und sichere dir die Chance auf einen  
coolen LEGO Preis!

Es gelten die Teilnahmebedingungen

### GAGNE



Rends-toi sur  
[www.LEGO.com/productfeedback](http://www.LEGO.com/productfeedback)

et donne-nous quelques commen-  
taires sur ce produit LEGO® pour  
avoir une chance de gagner un  
prix LEGO !

Voir Conditions Générales

### GANAN



Visita  
[www.LEGO.com/productfeedback](http://www.LEGO.com/productfeedback)

y envíanos tu opinión acerca de este  
set LEGO®. ¡Participarás en el sorteo  
de un premio LEGO!

Términos y Condiciones aplicables

### 获取奖品



登录  
[www.LEGO.com/productfeedback](http://www.LEGO.com/productfeedback)

给出关于此乐高®套装的简短反馈，  
就有机会获得炫酷乐高奖品

《条款及条件》适用

LEGO and the LEGO logo are trademarks of the/sont des marques de commerce du/  
son marcas registradas de LEGO Group. ©2017 The LEGO Group.

6188659